

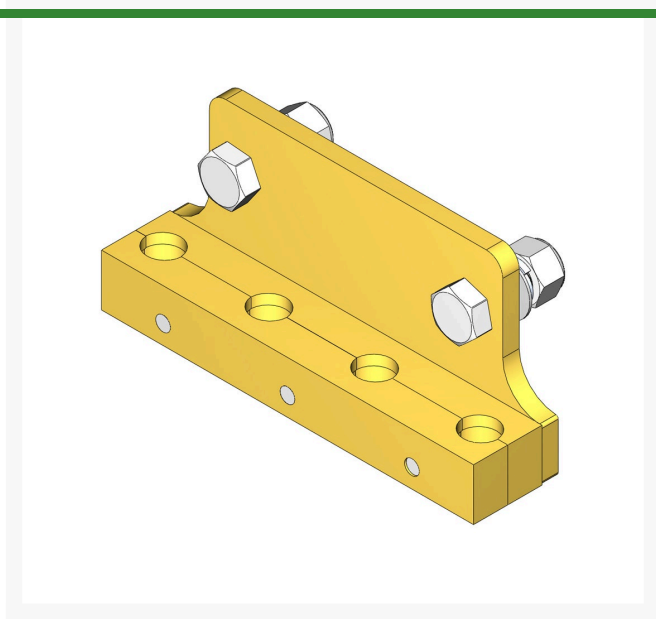

# Tine Holder Assy - 4 Tine 7/8 Mt

R100-7617



## Replaces

Toro 100-7617

## Specifications

Manufacturer R&R Products

## Fits Models

Toro ProCore 440

Toro ProCore 660

Toro ProCore 880

## Replacement Parts

R33028-00	Locknut - 16mm x 2.0 ESNA
R33098-00	Flatwasher - 16mm
R33115-050	Bolt - Hex HD M10-1.5 x 50
R33118-045	Bolt - Hex HD M16-2.0 x 45
R48-9590	Washer - Lock 10mm

## TURF MACHINERY SPARES LTD

3a Monument Way West Woking, GU21 5EN  
01483 764467

<https://turfmachinery.rrproducts.com/>