



Replaces John Deere 3235 Reel Mower

Parts

Medium Cutting Unit

Minuteman Roller System

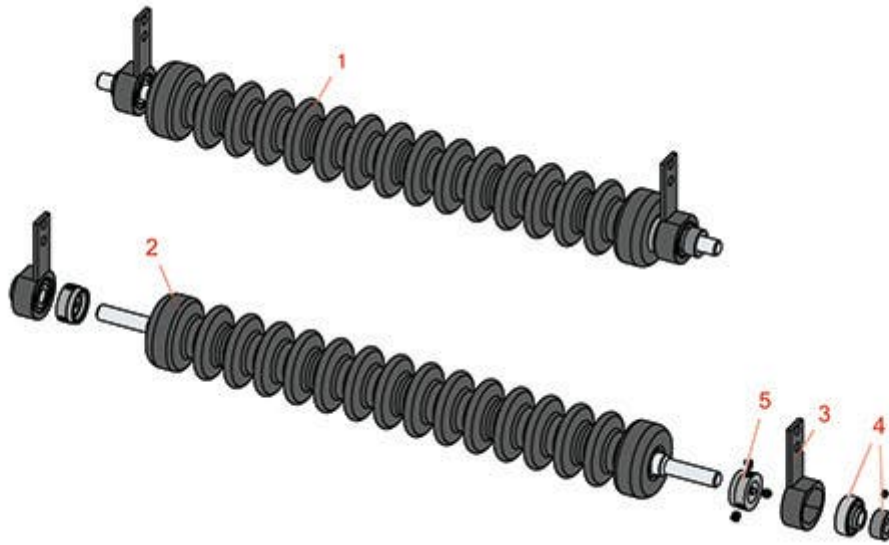

All original equipment manufacturers names and part numbers are used for identification purposes only, and we are in no way implying that our products are original equipment parts. Prices subject to change without notice.



Replaces John Deere 3235 Reel Mower

Parts

Medium Cutting Unit

Minuteman Roller System



Item No	R&R Part No.	OEM Part No.	Description	Qty Req	Order Quantity
---------	--------------	--------------	-------------	---------	----------------

Complete Minuteman Roller Systems

1	RMD2001		Minuteman Front Grooved Roller System	0	
---	----------------	--	---------------------------------------	---	--

Tech Note: Complete roller systems include roller and two brackets with bearings.:

Minuteman Rollers Only

2	RM528		Minuteman Grooved Roller Only	0	
---	--------------	--	-------------------------------	---	--

Tech Note: Use with Minuteman Roller Bracket System Only:

Other Parts Available

3	RD129		Bracket - Front RH/LH	0	
---	--------------	--	-----------------------	---	--

4	RMMB157		Bearing w/Locking Collar	0	
---	----------------	--	--------------------------	---	--

5	RMM3		End Hub - 7/8 ID	0	
---	-------------	--	------------------	---	--

All original equipment manufacturers names and part numbers are used for identification purposes only, and we are in no way implying that our products are original equipment parts. Prices subject to change without notice.