

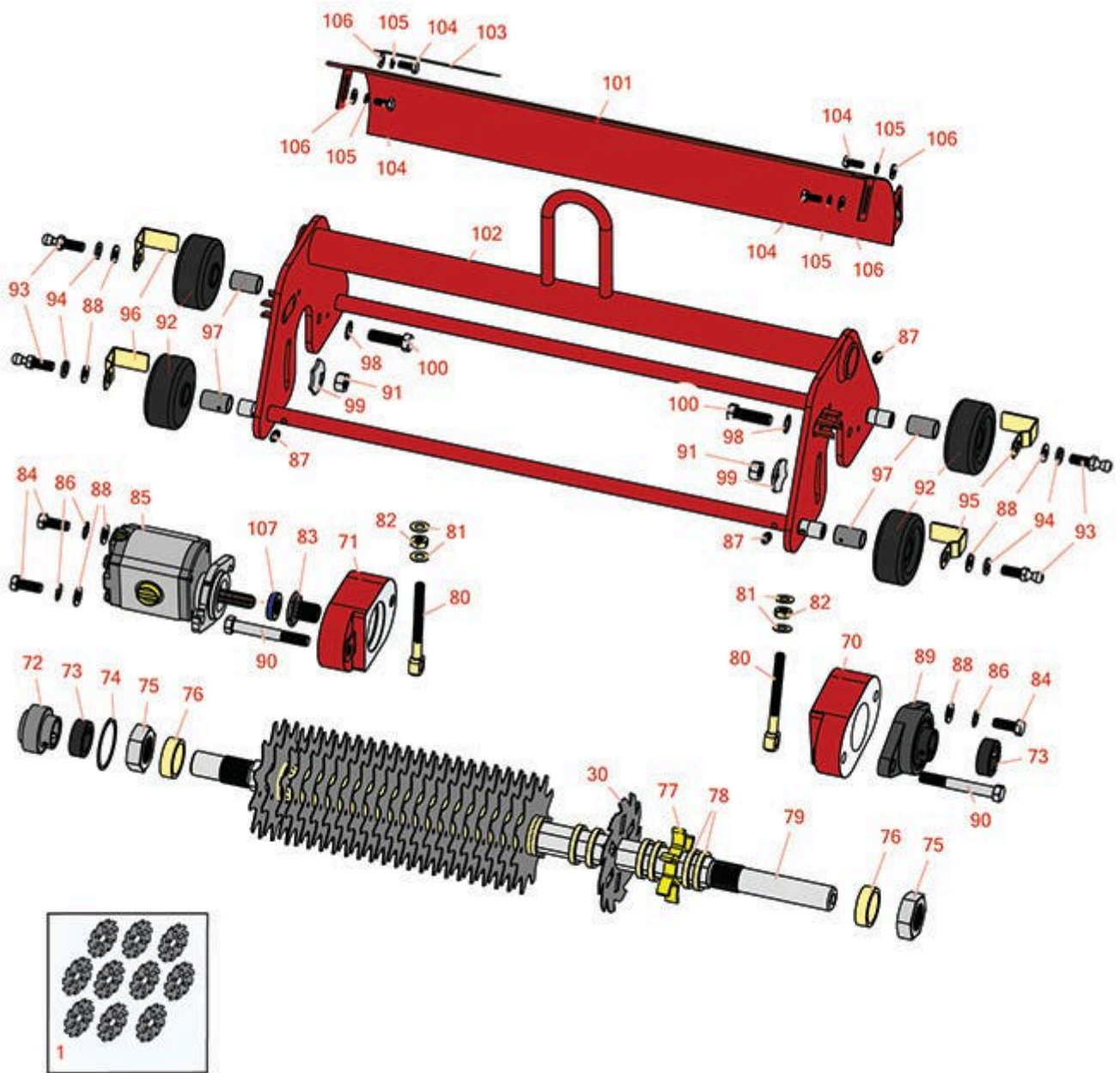

Replaces Toro Greensmaster 3000 Parts

Verti-Cut Unit - Model 04416

Verti-Cut Reel & Frame



All original equipment manufacturers names and part numbers are used for identification purposes only, and we are in no way implying that our products are original equipment parts. Prices subject to change without notice.



Replaces Toro Greensmaster 3000 Parts

Verti-Cut Unit - Model 04416

Verti-Cut Reel & Frame



Item No	R&R Part No.	OEM Part No.	Description	Qty Req	Order Quantity
---------	--------------	--------------	-------------	---------	----------------

Overhaul Kits

1	R106-6392	106-6392	Verti-Cut Blade Kit - 2mm Carbide Tipped	0	
---	------------------	----------	--	---	--

Tech Note: Includes Carbide Tipped Blades to rebuild 3 dethatching reels: 108 ea: R150209C Vertical Mower Blade:

Blades

30	R17-1590	17-1590	Verti-Cut Blade	36	
30	R150209C	106-6355	Verti-Cut Blade - Carbide Tipped 2mm	36	
30	R150109C	106-5422	Verti-Cut Blade - Carbide Tipped 1.2mm	36	

Other Parts Available

70	R17-1520	17-1520	Weight - Counter V-Cut	1	
71	R17-1610	17-1610	Housing - Bearing V-Cut	1	
72	R251-206	251-206	Bearing	1	
73	R251-77	251-77	Collar - Bearing	2	
74	R32120-77	32120-77	Ring - Retaining	1	
75	R3220-18	3220-18, 67-5840	Nut - Jam V-Cut Shaft	2	
76	R17-1580	17-1580	Spacer - V-Cut Reel 1/2	2	
77	R17-1600	17-1600	Spacer - V-Cut Reel 1/4	72	
78	R150230		Spacer - 1/2 Ventilated V-Cut	36	
79	R17-1570	17-1570	Shaft - Hex Verti-Cut	1	
80	R17-1510	17-1510	Eyebolt	2	
81	R17-1710	17-1710	Washer - Flat 3/8 Yellow USS	4	

All original equipment manufacturers names and part numbers are used for identification purposes only, and we are in no way implying that our products are original equipment parts. Prices subject to change without notice.



Replaces Toro Greensmaster 3000 Parts

Verti-Cut Unit - Model 04416

Verti-Cut Reel & Frame



Item No	R&R Part No.	OEM Part No.	Description	Qty Req	Order Quantity
82	R3217-7	01-188-0616, 1441, 22-13-AJD, 3217-7, 513296, 513415, 513425, 915113P	Nut - 3/8-16 Hex Plated	4	
83	R10-5100	10-5100	Nut - Splined 1-1/8 Long	1	
83	R93-1394	93-1394	Nut - Splined RH Thrd .812 Long	1	
84	R323-6	01-150-0010, 01-178-0608, 20-47-AD, 20-47-AGD, 3224-2, 323-6, 49-3510, 908034P, 908332	Bolt - Hex HD 3/8-16 x 1 GR5 YZ	2	
85	R105-9770	10-5090, 105-9770, 26-5690, 70-9800, 94-3506, 94-3507	Hydraulic Motor - Reel Quick Release	1	
<i>Tech Note: Fits Models 3000, 3050 & 3100:</i>					
85	R120-2072	100-6426, 108-6487, 112-9200, 120-2072, 93-1375	Hydraulic Gear Motor	1	
86	R3255-9	3255-9	Washer - Lock 3/8 Ext. Star	2	

All original equipment manufacturers names and part numbers are used for identification purposes only, and we are in no way implying that our products are original equipment parts. Prices subject to change without notice.



Replaces Toro Greensmaster 3000 Parts

Verti-Cut Unit - Model 04416

Verti-Cut Reel & Frame



Item No	R&R Part No.	OEM Part No.	Description	Qty Req	Order Quantity
87	R302-5	21-6010, 302-11, 302-37, 302-47, 302-5, 302-57, 302-58, 302-6, 31-0300, 32-9660, 60-0800, 62-3880, 92-4181	Fitting - Grease	4	
88	R453011	01-166-0100, 01-166-0120, 01-166-0270, 01-166-0500, 01-166-0600, 01-166-0620, 132-4593, 2356-3, 237-12, 24-10-AD, 24-11-AD, 24-11-BD, 24-12-AD, 24-12-BD, 30-9310, 32-8190, 3256-24, 3256-3, 3256-36, 3256-4, 453011, 47-9950, 48-9220, 513458, 7-0052	Washer - Flat 3/8 SAE Y/Zinc	2	
89	R251-247	251-247	Bearing - Flanged V-Cut Sft	1	
90	R324-13	324-13	Bolt - Hex HD 7/16 x 3-1/4	2	
91	R443114		Nut - 7/16 Hex Yellow Zinc	2	
92	R17-1630	17-1630	Wheel - Rubber Fits V-Cut Unit	4	

All original equipment manufacturers names and part numbers are used for identification purposes only, and we are in no way implying that our products are original equipment parts. Prices subject to change without notice.



Replaces Toro Greensmaster 3000 Parts

Verti-Cut Unit - Model 04416

Verti-Cut Reel & Frame



Item No	R&R Part No.	OEM Part No.	Description	Qty Req	Order Quantity
93	R94-2958	94-2958	Stud - Alloy Ball Joint	2	
94	R3254-6	01-166-0010, 01-166-0280, 01-166-0610, 3253-5, 3254-18, 3254-6, 3290-223, 48-9370	Washer - Lock 3/8	4	
95	R17-1640	17-1640	Scraper - Wheel LH	2	
96	R17-1650	17-1650	Scraper - Wheel RH	2	
97	R17-1620	17-1620	Bushing - Wheel	4	
98	R3255-16	3255-16	Washer - Lock 7/16 Ext Tooth	2	
99	R3290-334	3290-334	Washer - Lock Pyramidal	2	
100	R324-6	01-150-1690, 01-178-0712, 20-68-AGD, 3225-3, 324-6	Bolt - Hex HD 7/16-14 x 1-1/2	2	
101	R17-1530	17-1530	Shield - Grass V-Cut	1	
102	R17-1450	17-1450	Frame - V-Cut	1	
103	R354083	104-7729, 354083	Decal - Danger	1	
104	R329-1	329-1	Bolt - Hex HD 1/4-28 x 5/8	4	
105	R3255-7	3255-7, 76-5310	Washer - Lock 1/4 Ext Star Z	4	
106	R3256-22	24-9-BD, 3-1032, 3256-1, 3256-22, 93-0954, 93-0989	Washer - Flat 1/4 Yellow	4	

All original equipment manufacturers names and part numbers are used for identification purposes only, and we are in no way implying that our products are original equipment parts. Prices subject to change without notice.



Replaces Toro Greensmaster 3000 Parts

Verti-Cut Unit - Model 04416

Verti-Cut Reel & Frame



Item No	R&R Part No.	OEM Part No.	Description	Qty Req	Order Quantity
107	R353-585	353-585, 353-587, 354-34, 72-4380, 75-1210, 75-1270, 92-8863, 92-8864	Seal - High Pressure - Reel Motor	1	

All original equipment manufacturers names and part numbers are used for identification purposes only, and we are in no way implying that our products are original equipment parts. Prices subject to change without notice.