

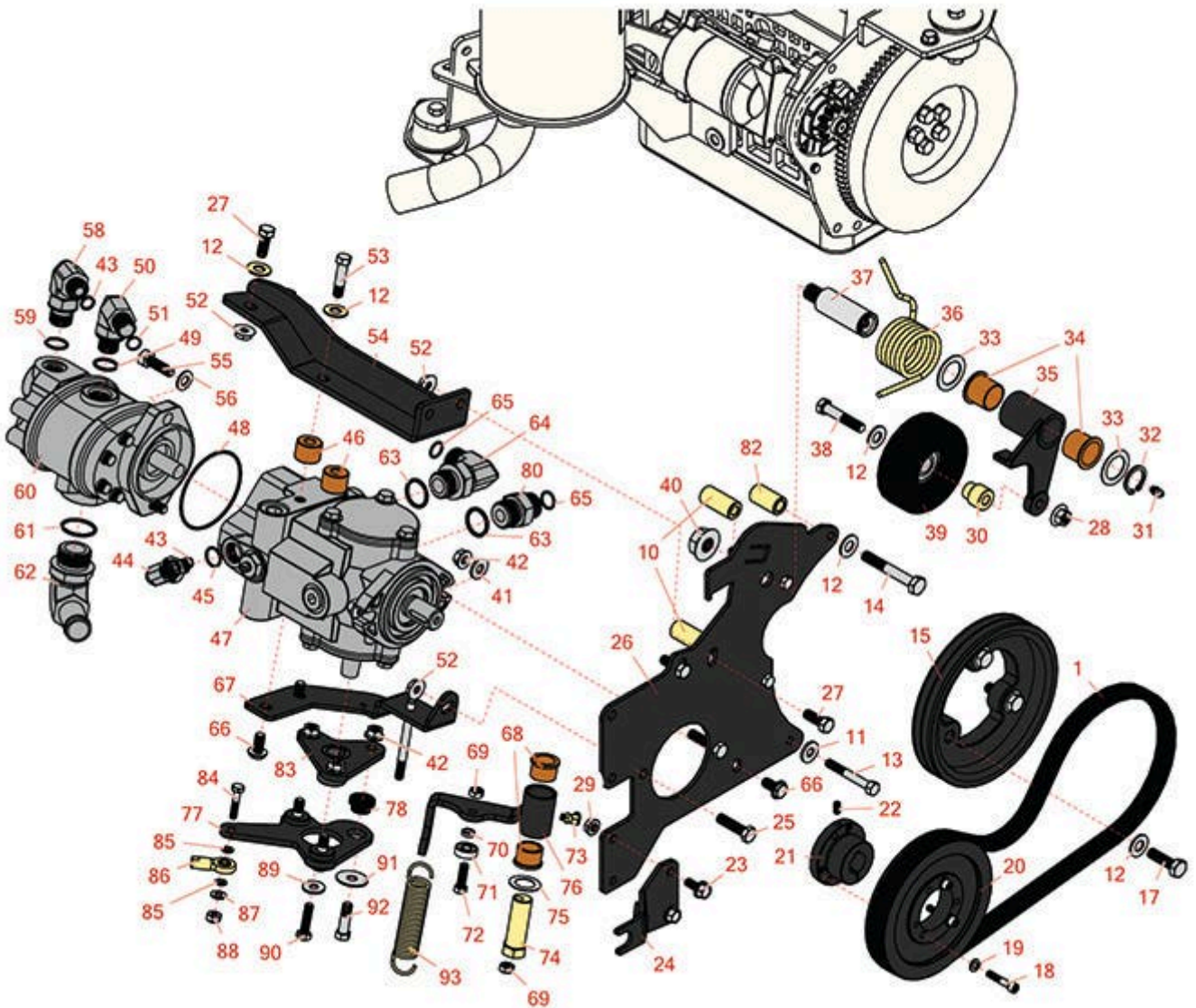

Replaces Toro Reelmaster 3100-D Parts

Traction Unit - Model 03207

Hydrostat & Neutral Arm



All original equipment manufacturers names and part numbers are used for identification purposes only, and we are in no way implying that our products are original equipment parts. Prices subject to change without notice.



Replaces Toro Reelmaster 3100-D Parts

Traction Unit - Model 03207

Hydrostat & Neutral Arm



Item No	R&R Part No.	OEM Part No.	Description	Qty Req	Order Quantity
Belts					
1	R150512	95-8730	Belt - Hydrastat	1	
Other Parts Available					
10	R95-8941	95-8941	Spacer - Pump Mount	4	
11	R87-8640	87-7510, 87-8640	Washer - Flat	3	
12	R80-6990	80-6990	Washer - Hardened	9	
13	R151379	33114-060, 42-9510	Bolt - Hx HD 8-1.25 x 65mm	1	
14	R42-9370	42-9370	Bolt - Hex HD 10mm x 70mm	1	
15	R99-3412-03	99-3412, 99-3412-03	Pulley	1	
17	R43-0090	43-0090, 95-8812	Bolt - 10mm x 1.25 x 25 Hex HD	3	
18	R316797	321-13	Bolt - 1/4-20 x 1-1/4	3	
19	R3253-3	01-166-0070, 01-166-0410, 23-9-GD, 24-7150, 3253-3, 3256-1, 352-167	Washer - Lock 1/4	3	
20	R93-6841	93-6841	Pulley	1	
21	R93-6842	93-6842	Bushing - Taper Lock 7/8	1	
22	R3245-36	3245-36	Screw - Set - Hx Soc HD	1	
23	R3234-5	3234-5, 62-3310	Bolt - 5/16-18x3/4 Hx Ser Was HD	2	

All original equipment manufacturers names and part numbers are used for identification purposes only, and we are in no way implying that our products are original equipment parts. Prices subject to change without notice.



Replaces Toro Reelmaster 3100-D Parts

Traction Unit - Model 03207

Hydrostat & Neutral Arm



Item No	R&R Part No.	OEM Part No.	Description	Qty Req	Order Quantity
24	R104-0464-03	104-0464-03, 99-3553, 99-3553-03	Bracket - Support	1	
25	R323-8	01-150-0060, 01-178-0612, 20-49-AD, 20-49-AGD, 323-8, 3273-41, 908036P	Bolt - Hex HD 3/8-16 x 1-1/2 GR8	2	
26	R95-8933-03	95-8933, 95-8933-03	Plate - Mount - Pump	1	
27	R3234-11	3234-11	Bolt - Hex Washer HD	4	
28	R32128-21	32128-21	Locknut - Flanged 3/8-16 Whiz Top Lock	1	
29	R32128-44	32128-44	Nut	2	
30	R95-8806	95-8806	Spacer	1	
31	R302-5	21-6010, 302-11, 302-37, 302-47, 302-5, 302-57, 302-58, 302-6, 31-0300, 32-9660, 60-0800, 62-3880, 92-4181	Fitting - Grease	1	
32	R458039	32151-36	Ring - Retaining	1	
33	R74-1810	74-1810	Washer	2	
34	R99-3631	99-3631	Bushing - Flanged	2	
35	R99-3623-03	99-3623-03	Arm - Idler	1	

All original equipment manufacturers names and part numbers are used for identification purposes only, and we are in no way implying that our products are original equipment parts. Prices subject to change without notice.



Replaces Toro Reelmaster 3100-D Parts

Traction Unit - Model 03207

Hydrostat & Neutral Arm



Item No	R&R Part No.	OEM Part No.	Description	Qty Req	Order Quantity
36	R95-8917	95-8917	Spring - Torsion	1	
37	R99-3529	99-3529	Shaft - Pivot - Idler	1	
38	R323-10	01-150-0680, 01-178-0616, 100-6663, 100-8320, 1489, 20-51-AD, 20-51-AGD, 3224-6, 323-10, 323-35, 908336	Bolt - Hex HD 3/8-16 x 2	1	
39	R95-8802	95-8802	Pulley- Idler	1	
40	R32128-54	32128-54	Nut - 5/8-18 Hex Serr Flanged	1	
41	R100-4852	100-4852	Washer - Hardened	2	
42	R3296-39	32127-25, 32128-36, 3290-357, 3296-17, 3296-22, 3296-39, 915663P, 99-7443	Locknut - 3/8-16 Nylon	6	
43	R237-22	107-8844, 237-22, 237-78	O-Ring	1	
44	R340-18	340-18	Hydraulic Fitting	1	
45	R237-79	237-79	O-Ring	1	
46	R99-3440	99-3440	Spacer	2	
47	R104-4890	104-4832, 104-4890	Pump - Piston	1	

All original equipment manufacturers names and part numbers are used for identification purposes only, and we are in no way implying that our products are original equipment parts. Prices subject to change without notice.



Replaces Toro Reelmaster 3100-D Parts

Traction Unit - Model 03207

Hydrostat & Neutral Arm



Item No	R&R Part No.	OEM Part No.	Description	Qty Req	Order Quantity
48	R353-949	353-949, 60-3520	O-Ring	1	
49	R237-80	237-80, 327-80	O-Ring	1	
50	R340-105	340-105	Hydraulic Fitting	1	
51	R237-30	23-6320, 237-30	O-Ring - Seal	1	
52	R32128-43	30-8990, 32128-43, 3290-357	Nut - Flanged Whiz - 3/8-16	4	
53	R323-19	323-19	Bolt - Hx HD 3/8-16 x 1 5/8	2	
54	R99-3436-03	99-3436, 99-3436-03	Support- Pump	1	
55	R3274-1	3274-1	Bolt - 3/8-16 x 1 1/4 Soc HD Cap	2	

All original equipment manufacturers names and part numbers are used for identification purposes only, and we are in no way implying that our products are original equipment parts. Prices subject to change without notice.



Replaces Toro Reelmaster 3100-D Parts

Traction Unit - Model 03207

Hydrostat & Neutral Arm



Item No	R&R Part No.	OEM Part No.	Description	Qty Req	Order Quantity
56	R453011	01-166-0100, 01-166-0120, 01-166-0270, 01-166-0500, 01-166-0600, 01-166-0620, 132-4593, 2356-3, 237-12, 24-10-AD, 24-11-AD, 24-11-BD, 24-12-AD, 24-12-BD, 30-9310, 32-8190, 3256-24, 3256-3, 3256-36, 3256-4, 453011, 47-9950, 48-9220, 513458, 7-0052	Washer - Flat 3/8 SAE Y/Zinc	2	
58	R340-77	340-100, 340-77, 95-7889	Hydraulic Fitting	1	
59	R237-42	237-42, 31-4160	O-Ring	1	
60	R95-8601	95-8601	Pump - Gear	1	
61	R237-117	237-117	O - Ring	1	
62	R56-9530	56-9530	Hydraulic Fitting - 90 Deg	1	
63	R237-81	237-81, 237.81, 327-81	O-Ring	1	
64	R340-139	340-139	Hydraulic Fitting - 90 Deg	1	

All original equipment manufacturers names and part numbers are used for identification purposes only, and we are in no way implying that our products are original equipment parts. Prices subject to change without notice.



Replaces Toro Reelmaster 3100-D Parts

Traction Unit - Model 03207

Hydrostat & Neutral Arm



Item No	R&R Part No.	OEM Part No.	Description	Qty Req	Order Quantity
65	R237-65	237-65, 237.65	O-Ring	1	
66	R3234-1	321-11, 3234-1	Bolt - Flanged Serrated Hex HD 3/8-16 x 3/4	2	
67	R95-8960-03	95-8960, 95-8960-03	Bracket- Neutral	1	
68	R256-113	256-113	Bushing - 3/4 ID x 1 1/8 Flange	2	
69	R3296-29	1-804256, 3290-357, 3296-29, 915662P	Locknut - 5/16-18 ESNA	2	
70	R100-4817	100-4817	Spacer - Bearing	1	
71	R251-259	251-259, 251-307	Bearing - Ball	1	
72	R3274-104	3274-104	Bolt - Hx Soc Button HD	1	
73	R302-60	302-60	Zerk - Grease 90 Deg.	1	
74	R76-8640	76-8640	Stud - Traction	1	
75	R3-6498	3--6498, 3-6498, 47-8270	Washer - Thrust	1	
76	R104-0422	104-0422	Neutral Arm Assy	1	
77	R99-3594-03	99-3594-03	Lever - Pump	1	
78	R63-9750	63-9750, 64-9750	Mount - Rubber	3	
80	R340-8	340-8	Adapter	1	
82	R95-8736	95-8736	Spacer	1	
83	R99-3598-03	120-5566, 99-3598-03	Hub Assy	1	

All original equipment manufacturers names and part numbers are used for identification purposes only, and we are in no way implying that our products are original equipment parts. Prices subject to change without notice.



Replaces Toro Reelmaster 3100-D Parts

Traction Unit - Model 03207

Hydrostat & Neutral Arm



Item No	R&R Part No.	OEM Part No.	Description	Qty Req	Order Quantity
84	R400112	321-8	Bolt - Hex HD 1/4-20 x 1-1/4	1	
85	R24M7139	24M7139, 3256-16, 33093-00, 43-5930	Washer - Flat 6mm	2	
86	R2411-41	2411-41	Rod End - Ball Joint	1	
87	R3256-22	24-9-BD, 3-1032, 3256-1, 3256-22, 93-0954, 93-0989	Washer - Flat 1/4 Yellow	1	
88	R301504	2296-42, 301504, 32127-24, 32128-33, 32146-17, 3296-16, 3296-42, 3296-42 , 915661P	Locknut - ESNA 1/4-20	1	
89	R88-7200	88-7200	Washer - Flat	1	
90	R3210-6	3210-6	Bolt - Hex HD	1	
91	R2844	2844	Washer	3	
92	R150776	95-3857	Bolt - Button HD Soc CS 3/8-16 x 1-1/2	3	
93	R94-1369	94-1369	Spring - Extension	1	

All original equipment manufacturers names and part numbers are used for identification purposes only, and we are in no way implying that our products are original equipment parts. Prices subject to change without notice.